

Quilt Block Pattern



Visit me on Instagram: (@olesyalebedenkodesign) 

Click here to check my patterns on Etsy: (MyPieceFullJourney) 

ASSEMBLY OF PIECES

SCALE 1:1

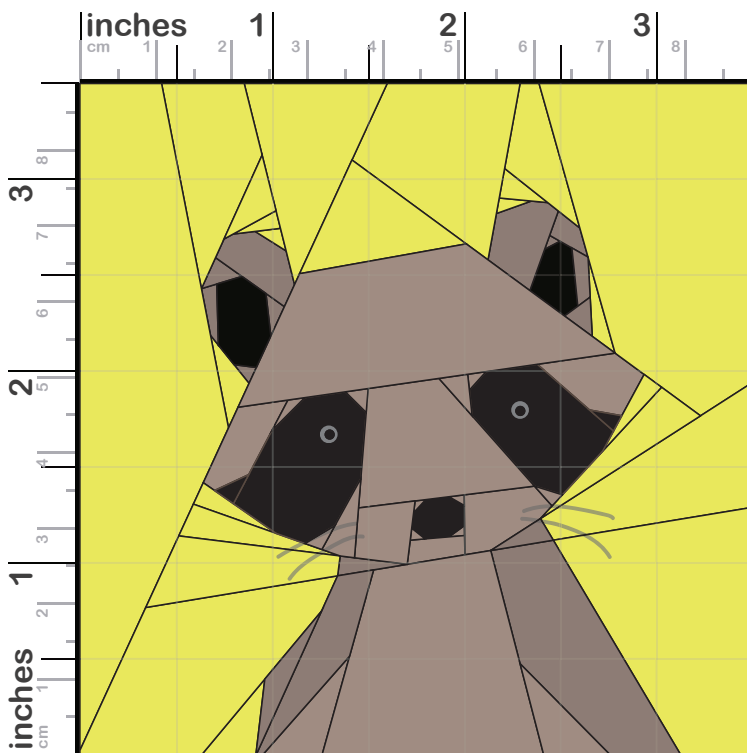

Look for my book on amazon.ca

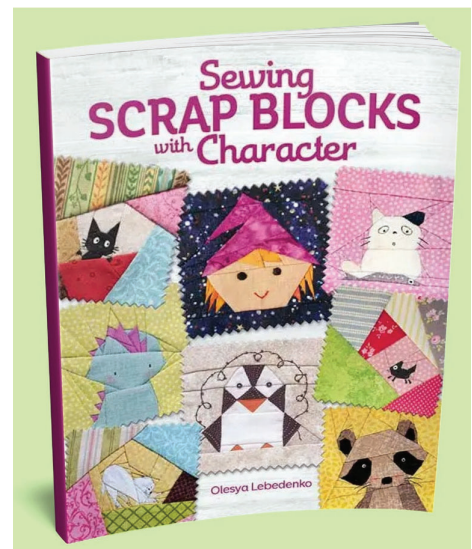

click here: [Sewing Scrap Blocks with Character](#)

by Olesya Lebedenko

This file prepared for Letter paper size format 8.5 by 11 inches:
United States, Canada, Latin America.

ASSEMBLY OF PIECES

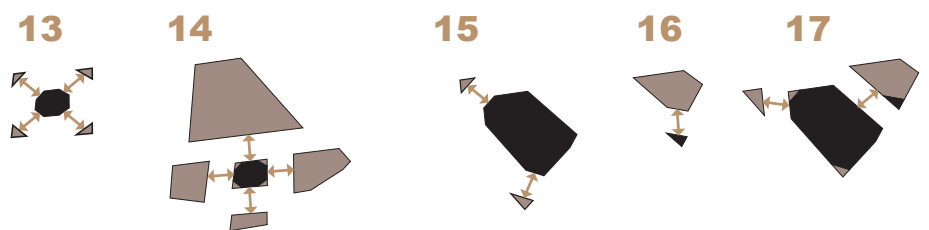
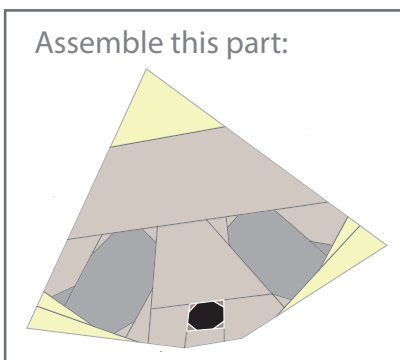
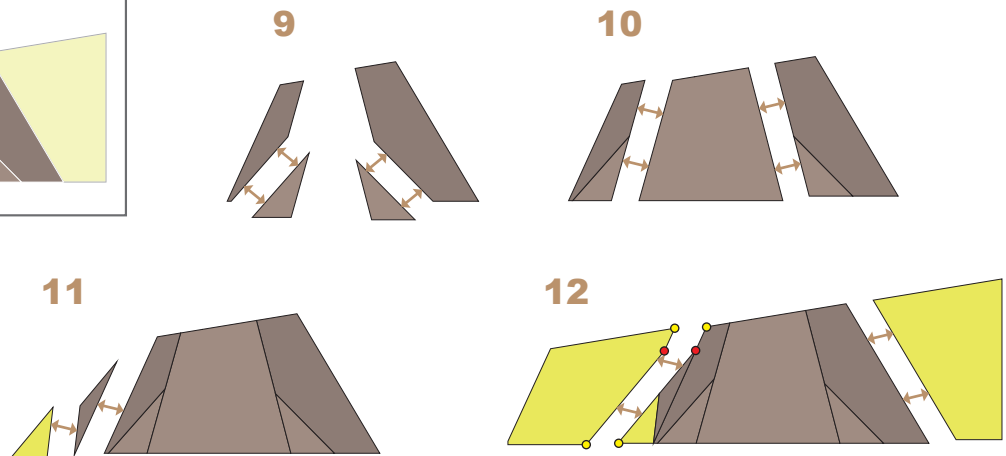
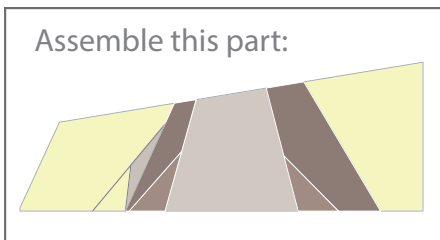
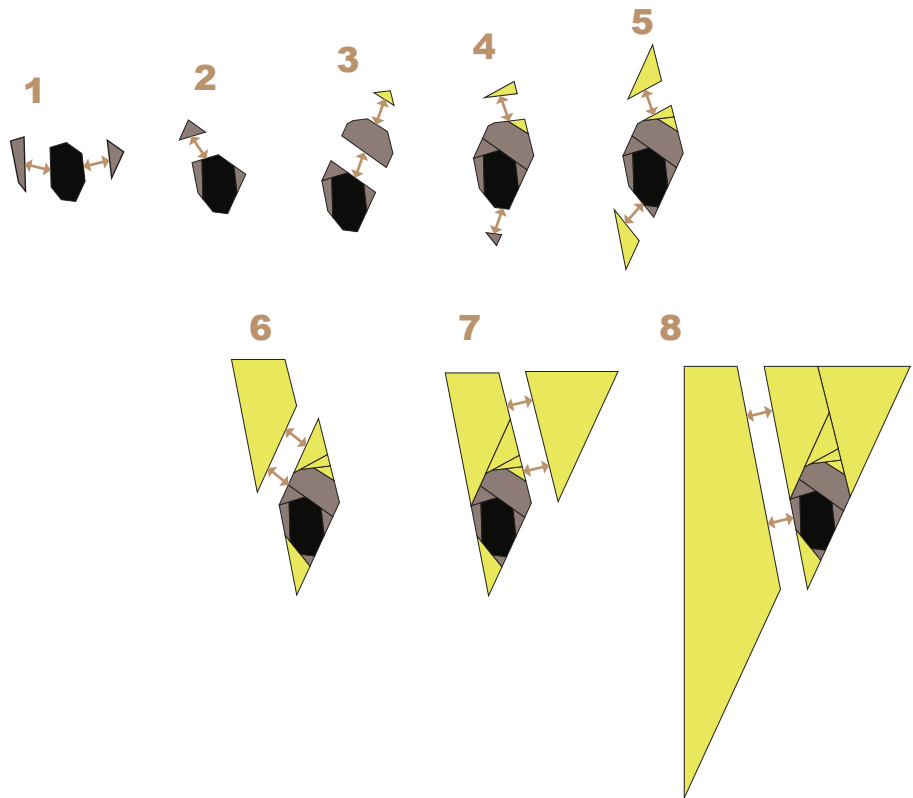
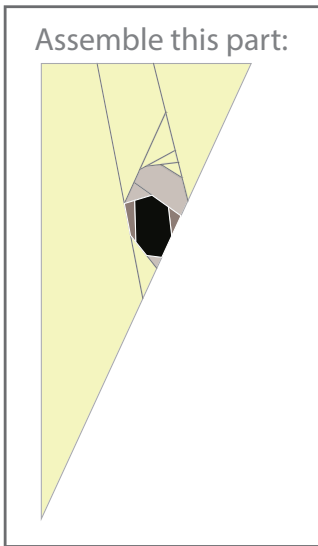

ASSEMBLY OF PIECES

18



19



20

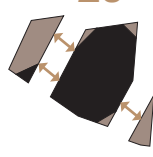

21

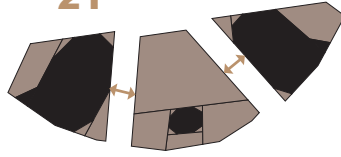

22

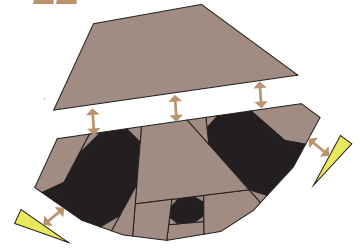

23

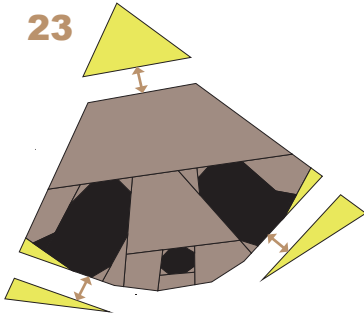

24

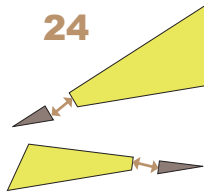

Assemble this part:

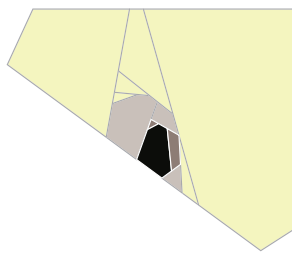

25



26



27



28

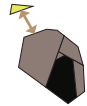

29

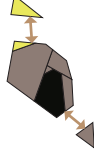

30

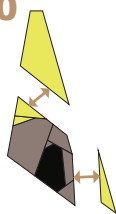

31

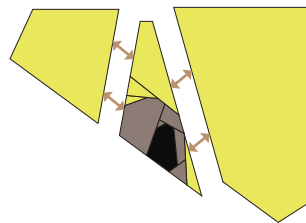

32

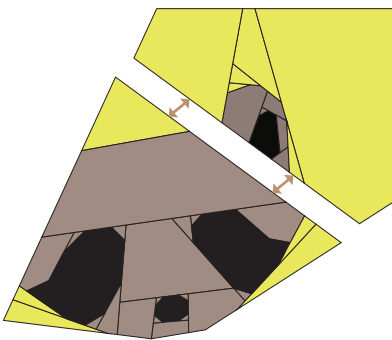

33

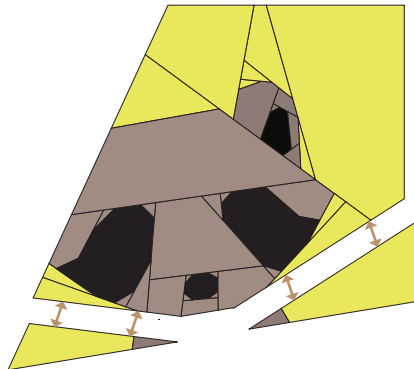

34

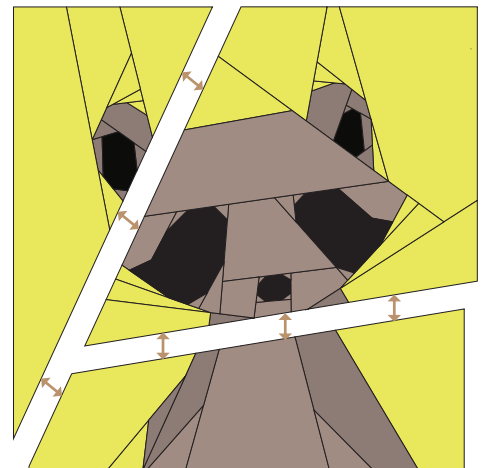

SCALE 1:1

9" PATTERN: part1

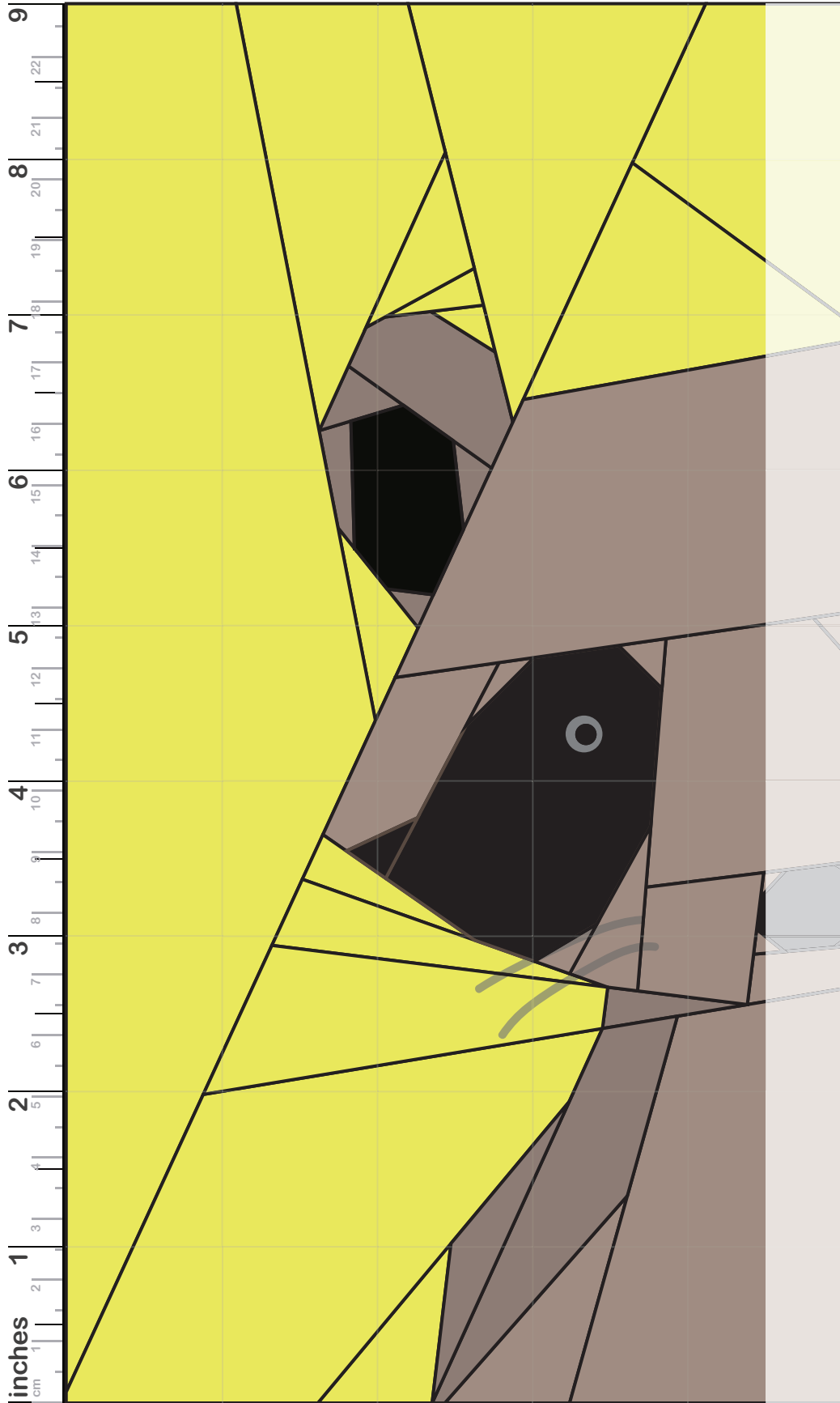

When printing the paper copy of the pattern choose in printer's settings «actual size (full size, 100%)». I recommend to use a color printer.

This file prepared for Letter paper size format 8.5 by 11 inches:
United States, Canada, Latin America.

SCALE 1:1

9" PATTERN: part2

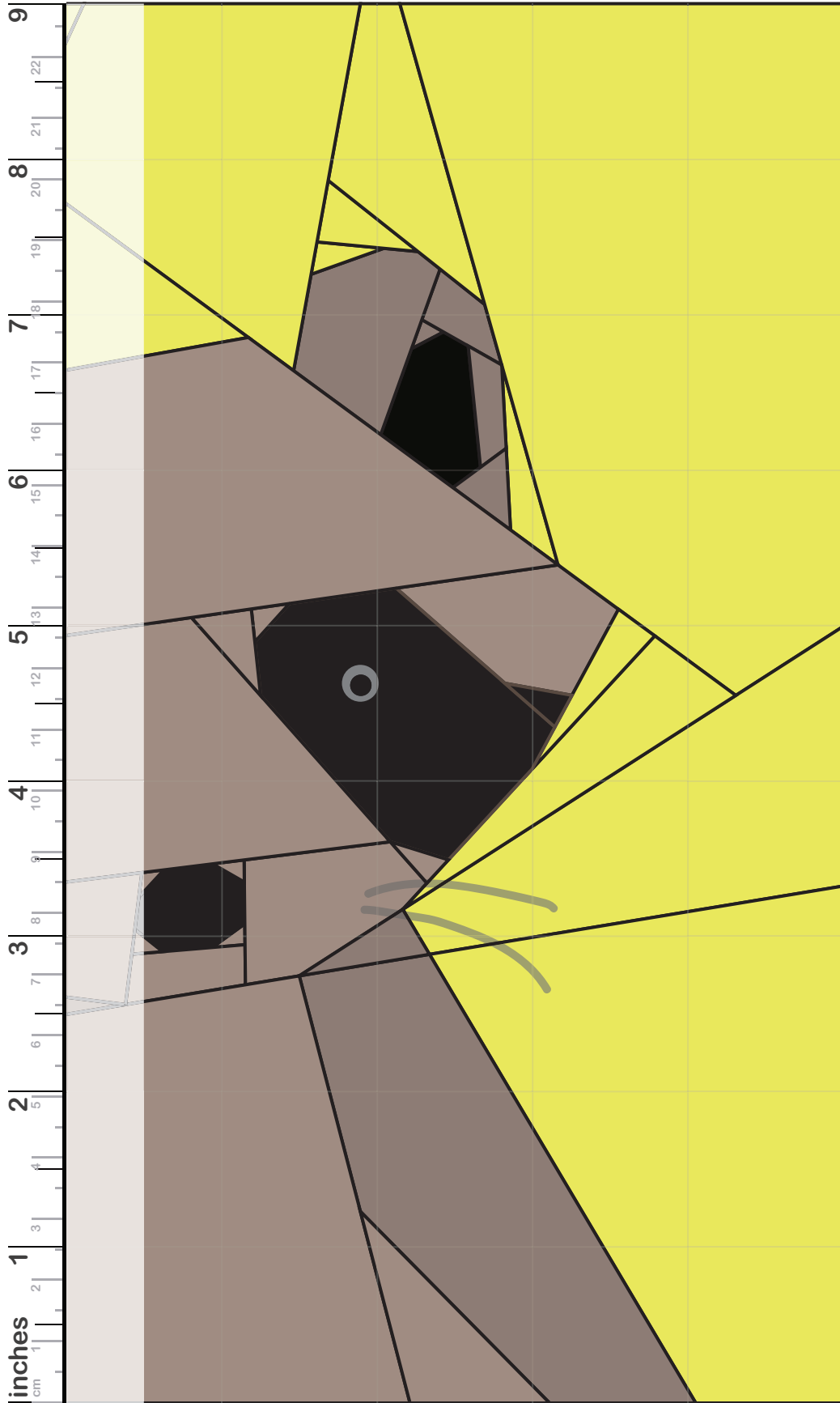

When printing the paper copy of the pattern choose in printer's settings «actual size (full size, 100%)». I recommend to use a color printer.

This file prepared for Letter paper size format 8.5 by 11 inches:
United States, Canada, Latin America.